

## Giant Tension Engineering Motorized Screen User Manual

### Product Electrical Specification

Voltage: 100V~120V, 60Hz  
or 220V~240V, 50Hz  
Power: 240W (MAX)

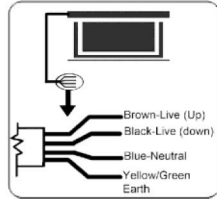

### Installation Method

Install the screen in the location where the audience can see the whole screen when it is fully extended.

The screen can be ceiling hanging only. Insure the right equipment is used.

The screen could be ceiling hanging on a brick or concrete surface **ONLY** and also make sure to use **EXPANSION ANCHOR BOLTS** only.

#### Ceiling Hanging:

Measure the distance between the holes in the end cases, mark out the same distance on the ceiling and drill holes for the screws, making sure the holes are in line with each other and parallel with the wall.

Screw the appropriate screw hooks into the holes and hang the screen.

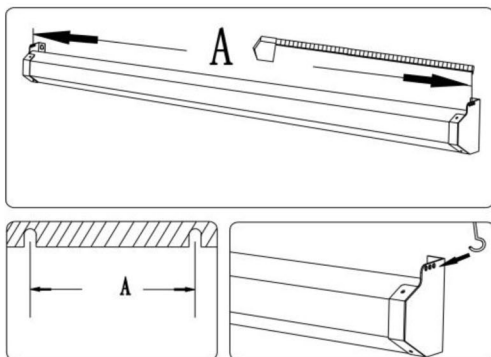

Ceiling hanging method

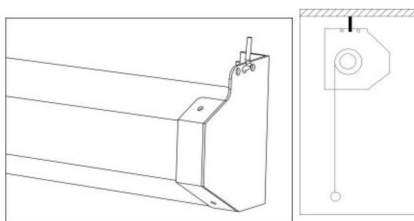

### Screen Operation

#### Wired control unit operation (Fig. 1)

Plug power cord into mains socket. (Make sure the correct voltage is supplied.) Position the cord so that it will not be tripped over, pulled or contact hot surfaces. If an extension cords is needed then use a cord with the same current rating.

#### To lower the projection surface (Fig. 2)

Toggle the switch to position < = >, the projection surface will lower itself, when it is fully extended it will stop automatically.

#### To retract the projection surface (Fig. 3)

Toggle the switch to position < - >, the projection surface will retract into its case, when it is fully retracted it will stop automatically.

To stop the projection surface manually at an intermediate position, toggle the switch to the < O > position.

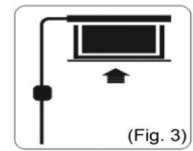
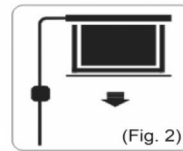
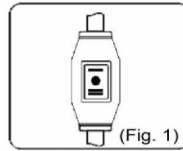

#### Wireless control unit operation (Fig. 4)

#### To lower the projection surface

Press the bottom button on the control unit, the projection surface will lower itself, when it is fully extended it will stop automatically.

#### To retract the projection surface

Press the top button on the control unit, the projection surface will retract into its case, when it is fully retracted it will stop automatically.

#### To stop the projection surface

Manually at an intermediate position, press the middle button on the control unit.



### Adjusting method

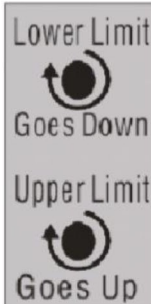

**Lower limit**—Adjust the stopping level of slat when fully extend. Turn "lower limit" switch in clockwise direction let the slat go closer to the ground.

**Upper limit**—Adjust the stopping level of slat when fully retract. Turn "upper limit" switch in clockwise direction let the slat go closer to the casing.

Ver 1.1

